

INON

INON UW Tripod Hub

Thank you for purchasing INON product.

The INON UW Tripod Hub is a key component to create an underwater tripod system. Designed to use INON 「Carbon Telescopic Arm」 etc. as tripod legs. Installing an optional 「UW 3-Way Panhead」 further provides précised yet comfortable camera position adjustment.

Name of parts

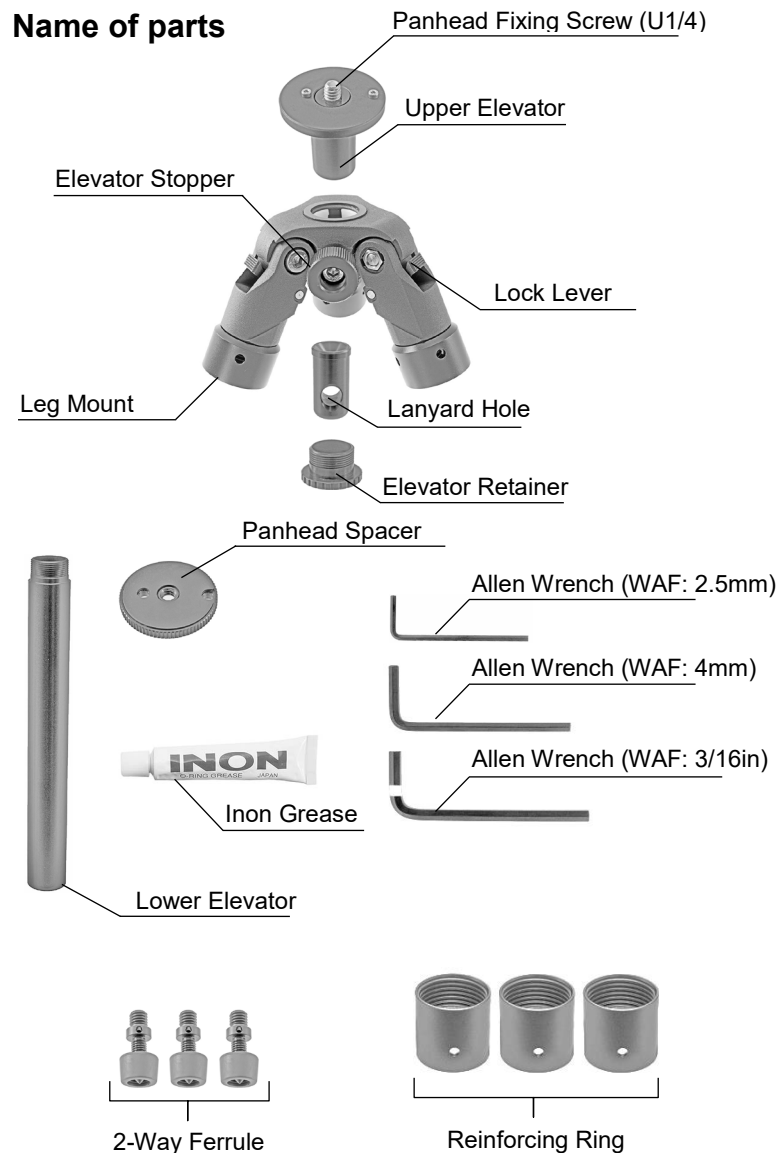

Compatible products

【Leg mount】

- Carbon Telescopic Arm SS/S/M/L
- Stick Arm XS-T/SS-T/S-T/M-T

* Please note that this product is only compatible with 【modified】 Stick Arm having screw hole on its ball mount. 【Original】 Stick Arm is **not compatible with this product as they do not have threaded hole.**



【Modified version】

【Panhead Fixing Screw】

- INON 「UW 3-Way Panhead」
- INON 「Tripod Adapter for D Holder」
- INON 「Shoe Base 1/4-20UNC」(head part)
- INON 「Shoe Base M6」(head part)
- INON 「Tripod Adapter」
- INON 「Single Light Holder LE for Tripod」
- INON 「Single Light Holder LF for Tripod」
- INON 「SD Mount Cage」 「SD Front Mask」 「SD Mount Base」 products.
- An underwater housing equipped with 5mm or deeper tripod hole (1/4-20UNC).

Preparation

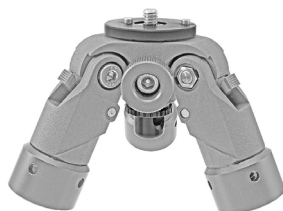

Above image shows product onfiguration when you unpack the box Please disassemble them by following procedure before using.

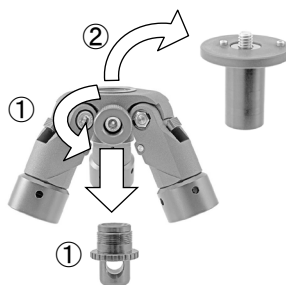

- ① Separate the Elevator Stopper by unscrewing the sleeve on it.
- ② Pull out the Upper Elevator from the UW Tripod Hub.

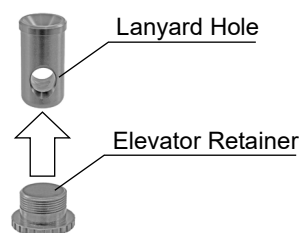

You can remove the Lanyard Hole if you don't use it.

Installing Legs



Optional *Carbon Telescopic Arms* or *Stick Arms* (-T version) are usable as legs.

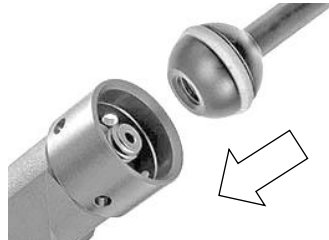

Screw ball-joint in Leg Mount.

Stick Arm

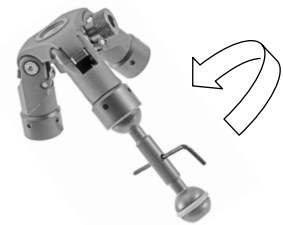

When installing *Stick Arm*, tighten completely by using supplied Allen Wrench (WAF: 2.5mm) sticking into a hole on the arm stem.

Carbon Telescopic Arm

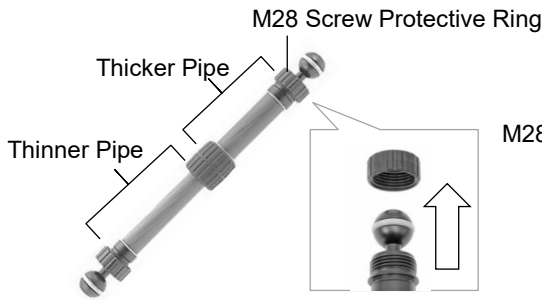

Remove *M28 Screw Protective Ring* on the thicker pipe side.

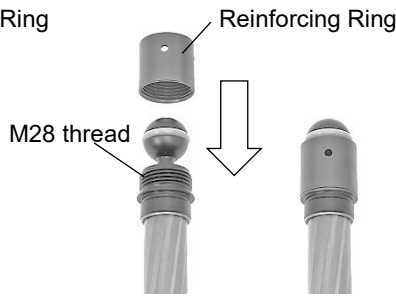

Screw packaged *Reinforcing Ring* on the M28 thread part.



Install the ball-joint fitted with the *Reinforcing Ring* into the Leg Mount.

Installing 2-way Ferrule

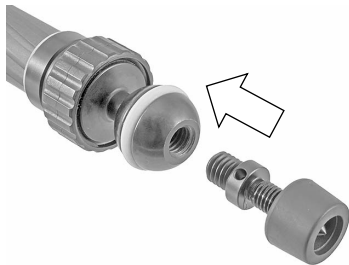

Screw the 2-Way Ferrule on a ball-joint.

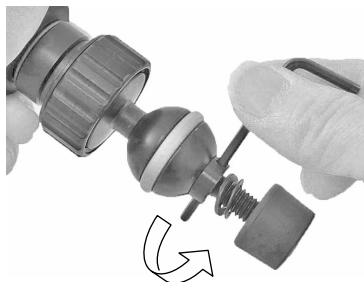

Retighten by using supplied Allen Wrench (WAF: 2.5mm) sticking into a hole on the ferrule stem to screw in completely

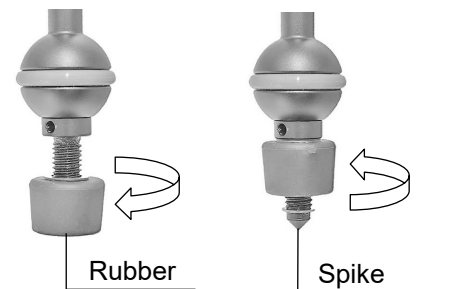

The 2-way Ferrule has two configurations either rubber or spike by screwing rubber part downwards or upwards to use for different circumstances.

Directly Install Underwater Housing

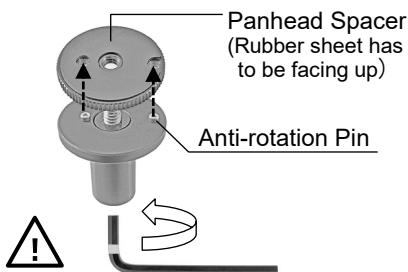

Make sure to attach the Panhead Spacer
Put the Panhead Spacer on the upper elevator. The anti-rotation pins should seat inside of holes of the spacer. Fasten them by tightening a cap screw inside of the upper elevator by supplied Allen Wrench (3/16 in).

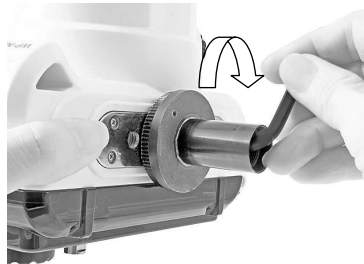

Attach the upper elevator on the bottom of the underwater housing by screw the Panhead fixing Screw into 1/4 tripod screw hole of the housing.

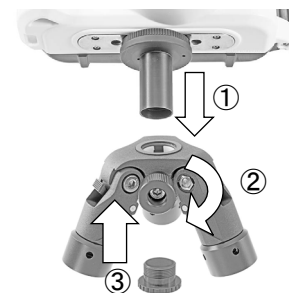

- ① Install the upper elevator on the hub.
- ② Tighten the Elevator Stopper.
- ③ Attach the Elevator Retainer on the bottom of the Upper Elevator.

Installing Optional Tripod Head etc.

【Installing UW 3-Way Panhead】

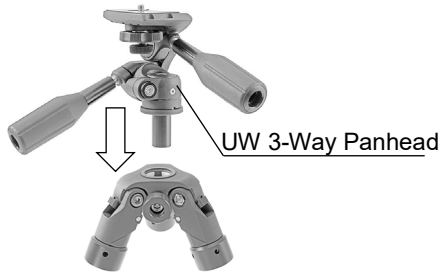

Refer to a user manual of the UW 3-Way Panhead for detail of installation.

【Installing Shoe Base Head】

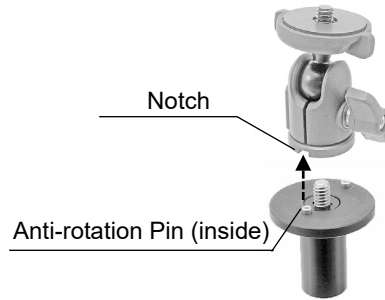

Attach Shoe Base Head so that inner Anti-rotation Pin seats inside of the notch of the Shoe Base Head. Then fasten them with the Allen Wrench (3/16in).

Adjusting Height by Elevator

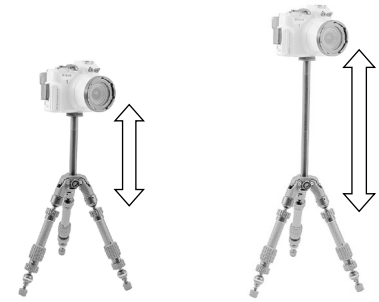

1x Lower Elevator

2x Lower Elevators

Joining Upper Elevator and Lower Elevator enables height adjustment. It is possible to add another Lower Elevator (option).

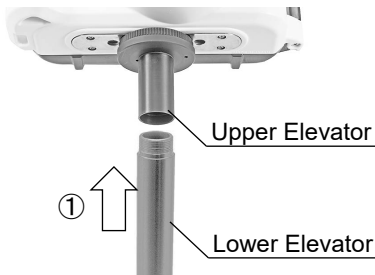

① Screw the Lower Elevator in the bottom of the Upper Elevator.

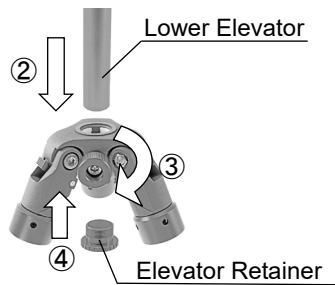

② Install the Lower Elevator on the hub
③ Tighten the Elevator Stopper. Attach the Elevator Retainer on the bottom of the elevator.

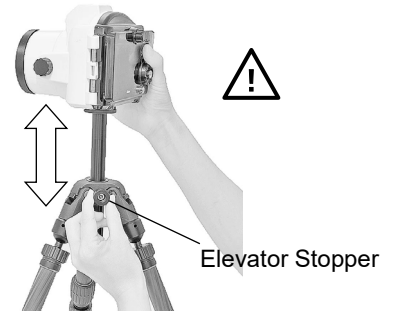

When adjusting elevator height, hold the underwater housing and loosen the elevator knob. Once height is determined, tighten the elevator knob firmly not to fall the elevator down.

Changing Opening Angle

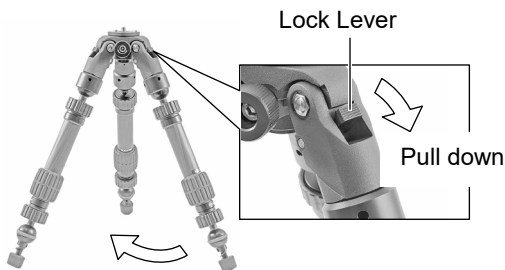

Close opening of legs slightly from high position to release (pull it down) the Lock Lever.

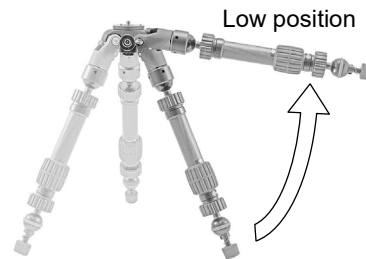

While the Lock Lever being released, open the leg till it stops where the leg is at Low Position.

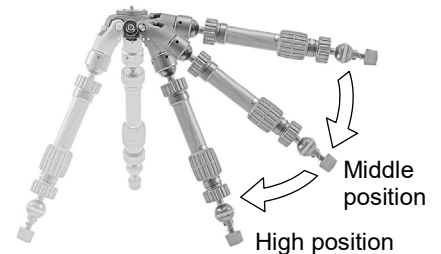

By closing a leg from Low Position, you can set it at Middle Position then High Position. If the Lock Lever doesn't return to lock in any position, push up the Lock Lever.

Adjusting Opening Torque



Tightening/loosening a fixing Bolt on a joint by supplied Allen Wrench (WAF:4mm) will adjust opening torque.

Low Position



The Lower Elevator is NOT usable when Low Position is selected

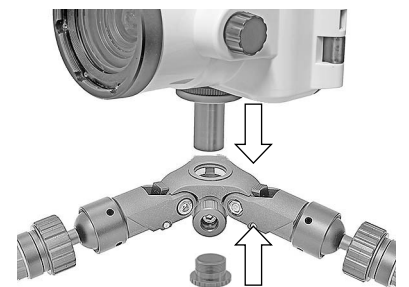

Make sure to attach Elevator Retainer on the bottom of the Upper Elevator.

Using the Elevator Upside-down

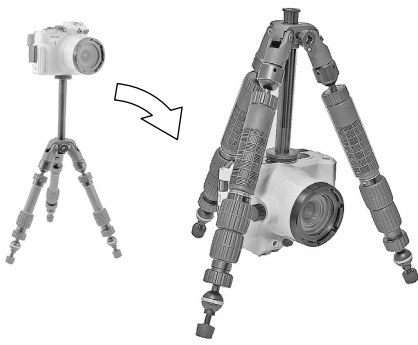

The Elevator can be installed upside-down to hang camera system as like above image.

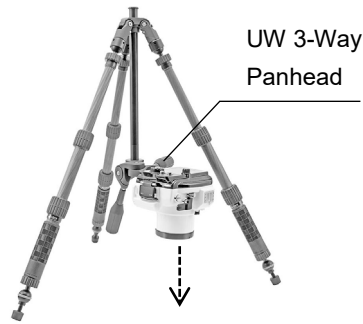

It is possible to shoot right under the tripod when combined with an optional "UW 3-Way Panhead". The panhead should be installed front side back.

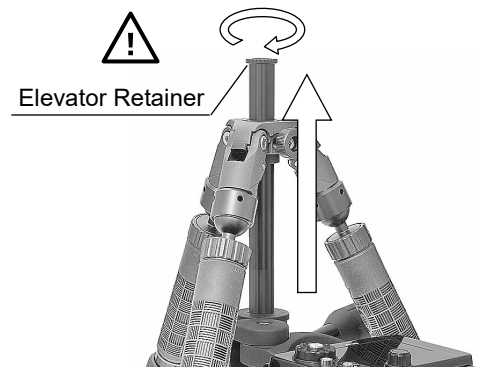

After installing the Elevator on the UW Tripod Hub, tighten the Elevator Stopper and make sure to attach the Elevator Retainer to prevent accidental falling off.

Enhance Stability of Tripod

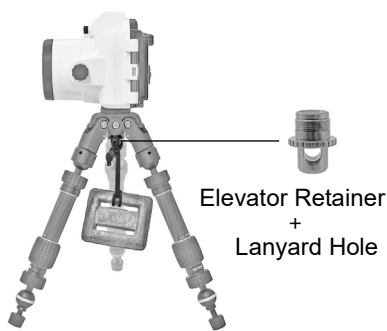

By using packaged Lanyard Hole, a diving weight can be hung down as per above image.

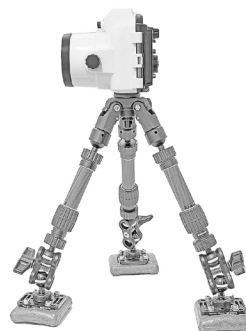

It is also possible to attach a diving weight combined with INON Weight Plate by compatible adapter.

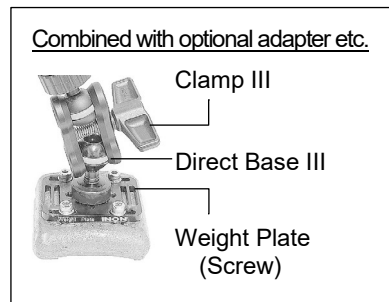

Maintenance:

- After each use, remove arms/tripodhead etc from this product, and rinse them with fresh water to dissolve any salt build-up and clean(*). Place in shaded and well ventilated area to completely dry. Never apply flame or direct heat or deformation/damage may result.

(*) After use, immerse the product in fresh water for half a day to one day to thoroughly dissolve salt, which will greatly reduce salt build-up on moving parts.

- Make sure to apply packaged INON grease on greasing points indicted in below images to prevent rust or anchoring by erosion.



- DO NOT clean with organic solvent like alcohol, benzene or thinner and oil and fat containing /chemical material like rust inhibitor, lubricant, polish or chemical agents (especially alkaline cleaning agents).

Storage:

- After completely dry, store the product in shaded, well ventilated and dry area. Avoid storing near chemicals or in the area with cold/high temperature, high humidity or large temperature and humidity fluctuations to prevent deformation, mold, rust or corrosion.
- Keep this product out of reach of children. They may swallow accessories or small parts of this product. See a doctor immediately if a child swallow accessories or small parts.

Handling Precautions:

- When transporting on land, remove combined camera from the tripod to carry separately. Otherwise camera may be accidentally fell off causing personal injury or property damage etc.
- Depending on combined camera system, center of gravity may not help stable placement of the tripod to cause abrupt falling down resulting in personal injury, malfunction of combined camera or property damage. Take extra caution to keep stable placement of the tripod if combined system is not stable enough.

Options:

- Make sure to install combined system properly and tighten the Elevator Stopper etc. completely according to this user manual to prevent accidental fell off of the camera or falling down of whole system. Also make sure to open tripod legs wide enough. Insufficient opening may increase instability to cause camera shake or abrupt falling down.

- UW 3-Way Panhead

A panhead exclusively designed for this product. Equiped with large handles to support easy and precised camera positioning. Bundled adapter further assures reliable installation of a housing in addition to wide compatibility of combined housing type.



- Shoe Base 1/4-20UNC Head

- Shoe Base M6 Head

Upper parts of 「Shoe Base 1/4-20UNC」, 「Shoe Base M6」 or 「Shoe Base BALL」. You can choose either parts to attach on this product directly to create compact tripod system with 「1/4 in screw」, 「M6 screw」 or 「ball joint」 on top dependig on combined product.

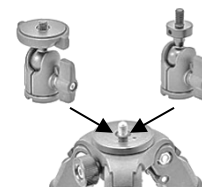

- Ferrule Ball Set (contains 3)

Designed to install on 2-Way Ferrules packaged in UW Tripod Hub and connect each ball with a ball-joint of tripod leg by a clamp to enhance stable placement of the tripod system on uneven ground like a rock.



- Tripod Adapter for D Holder

An adapter to link an INON D Holder and this product enabling to attach an underwater housing combined with D Holder on this product.



- Carbon Telescopic Arm (SS/S/ML)

- Stick Arm (XS-T/SS-T/S-T/M-T)

Compatible arms to use as tripod legs for this product. Carbon Telescopic Arms for flexible tripod leg length or Stick Arms for compact tripod system

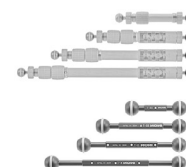

- Weight Plate(Screw Type)

- Direct Base III

- Clamp III

Example optional adapters to ehcnace stability of the tripod system by attaching dive weights on leg ends.

- Lower Elevator

Same as bundled 「Lower Elevator」. Connecting extra 「Lower Elevator」 attached on the bundled 「Lower Elevator」 will add another 140mm/5.5 in. in height.

- 2-Way Ferrule

The 2-Way Ferrule packaged with this product, is available to purchase for spare or replacement.

INON UW Tripod Hub Specifications [*1]	
Model	UW Tripod Hub
Size [*2]	68mm/2.7in.(W)×80mm/3.1in.(H)×63mm/2.5in.(D)
Weight [*2]	[air] 284g/10.0oz, [U/W] approx.181g/6.4oz
Material/finishing	Alluminum alloy/stainless/POM etc.

*1 Specification is subject to change without prior notice

*2 Excluding Ferrules and Lower Elevator.

INON Inc.
 2-18-9, Dai, Kamakura,
 Kanagawa 247-0061 JAPAN
 E-mail support@inon.co.jp
 Fax. +81(0)467-48-2178
 URL <http://www.inon.jp/>